

KrosFlo® FS TFF Systems

Set-up Guide

For use with KrosFlo® FS-15 and FS-500 TFF Systems



The information contained in this document is subject to change without notice.

With respect to documentation accompanying product, Repligen makes no warranty, express or implied. Any and all warranties related to the documentation accompanying product are expressly disclaimed. Customer shall refer to the terms and conditions of sale governing the transaction for any and all warranties for the Product.

Repligen Corporation shall not be liable for errors contained herein or for incidental or consequential damages in connection with the furnishing, performance, or use of this material.

No part of this document may be photocopied, reproduced, or translated to another language without the prior written consent of Repligen Corporation.

Products are not intended for diagnostic or therapeutic use or for use in vivo with humans or animals.

For further information, please contact Repligen Corporation at www.repligen.com.

©2021 Repligen Corporation. All rights reserved. The trademarks mentioned herein are the property of Repligen Corporation and/or its affiliate(s) or their respective owners.

Customer Support

customerserviceUS@repligen.com

508-845-6400

Repligen Corporation

111 Locke Drive

Marlborough, MA, USA 01752

www.repligen.com

Contents

1. Intended use	6
2. System notices	7
3. Compliance information	7
4. KrosFlo® FS-15 TFF System specifications	8
5. KrosFlo® FS-500 TFF System specifications	10
6. Unboxing checklist	12
7. Optional, additional purchases	16
8. Set-up	17
8.1 KrosFlo® FS-500 base plate	18
8.2 Assembling the base plate	18
9. System cable connections	19
10. Software set up	20
10.1 Minimum system requirements for optional, customer-provided computer	20
10.2 Supported control software	20
10.3 Setting up the software (overview)	20
11. Tube set installation	21
11.1 Tube set guidelines	21
11.2 Feed tube set installation	22
11.3 Reinforced feed tube set	22
11.4 Retentate tube set	22
11.5 Permeate Tube Set	23
11.6 Auxiliary tube set installation	23
11.7 Permeate Flowmeter (KrosFlo® FS-500 only)	23
12. Index	24

List of tables

Table 1.	Safety icons.....	7
Table 2.	Product use limitation	8
Table 3.	KrosFlo® FS-15 TFF System output	8
Table 4.	KrosFlo® FS-15 TFF System input.....	8
Table 5.	KrosFlo® FS-15 TFF System construction	9
Table 6.	KrosFlo® FS-15 TFF System environment	9
Table 7.	KrosFlo® FS-15 TFF System materials of construction.....	9
Table 8.	KrosFlo® FS-500 TFF System output	10
Table 9.	KrosFlo® FS-500 TFF System remote outputs.....	10
Table 10.	KrosFlo® FS-500 TFF System input.....	10
Table 11.	KrosFlo® FS-500 TFF System remote inputs	10
Table 12.	KrosFlo® FS-500 TFF System construction.....	11
Table 13.	KrosFlo® FS-500 TFF System environment	11
Table 14.	KrosFlo® FS-500 TFF System materials of construction.....	11
Table 15.	KrosFlo® FS-15 TFF System unboxing checklist	12
Table 16.	KrosFlo® FS-500 TFF System unboxing checklist	14
Table 17.	KrosFlo® FS-15 TFF System additional components.....	16
Table 18.	KrosFlo® FS-500 TFF System additional components.....	16

List of figures

Figure 1.	Space requirements for KrosFlo® FS-15	17
Figure 2.	Space requirements for KrosFlo® FS-500 - Option A.....	17
Figure 3.	Space requirements for KrosFlo® FS-500 - Option B	18
Figure 4.	KrosFlo® FS-500 Base plate set-up	18
Figure 5.	KrosFlo® FS-15 TFF System cable connections	19
Figure 6.	KrosFlo® FS-500 TFF System cable connections	19
Figure 7.	KrosFlo® FS-15 tube set	21

+

Abbreviations

ABV	Automatic Backpressure Valve
AC	Alternating current
cm	Centimeter
C	Concentration
CE	Conformité Européenne
CF	Concentration factor
cm	Centimeter
D	Diafiltration
DV	Diafiltration volume
FAS	Field Application Specialist
Hz	Hertz
in	Inches
kg	Kilogram
lbs	Pounds
LPM	Liters per minute
PE	Pressure Sensor
PID	Proportional, Integral and Derivative
PPE	Personal protective equipment
PSI	Pounds per square inch
TFDF	Tangential Flow Depth Filtration
TMP	Transmembrane Pressure
UL	Underwriters Laboratories
VT	Volumetric throughput

1. Intended use

The KrosFlo® Flat sheet (FS) Tangential Flow Filtration (TFF) Systems, or FS-15 and FS-500, are the ideal automated TFF systems for flat sheet membrane single-use applications. The FS complete systems come equipped with all components required to perform fully automated TFF processes right from the box, enabling true walk-away TFF processing.

This Set-up Guide provides a condensed description of your KrosFlo® TFF System. This document does not describe the details of setting up for a specific application. See the KrosFlo® TFF System Application Guide for more information.

User guides are available at <https://www.repligen.com/resources/quality#User-Guides>

For additional information regarding the operation of KF Comm 2 or 2C software, please refer to KF Comm 2 Software User Guide (IF.UG.022).











For additional information regarding specifications and use of auxiliary scales, please refer to KrosFlo® TFF System – Auxiliary Scale Use Guide (420-14871-001 and 420-14871-002).

For additional information regarding specifications and the use of Konduit, UV photometer and Conductivity please refer to KrosFlo® KR2i / KMPi TFF Systems User Guide and Operating Instructions (400-12355-000).

For further support with troubleshooting or process optimization, please contact your local Repligen Field Application Scientist.

2. System notices

Table 1. Safety icons

Danger		High voltages exist and are accessible. Use extreme caution when servicing internal components. Remove power from the pump before any cleaning operation is started.
Warning		To avoid electrical shock, the power cord protective grounding conductor must be connected to the ground. Not for operation in wet locations as defined by EN61010-1.
Warning		Pressure: Do not allow pressure to exceed 65 PSI
Warning		Moving parts: Pumps contain moving parts. Keep fingers away from pumps and pinch valves during operation. Stop pump before loading or unloading tubing.
Warning		Electric shock: Remove power from the pump before attempting any maintenance.
Warning		Tubing: Tubing breakage may result in fluid being sprayed from pump. Use appropriate measures to protect operator and equipment.
Warning		Lubricant: Do not contaminate the lubricant in the container, on the shaft or on the seal with foreign material. Failure to observe this precaution may result in damage to the seal and premature failure of the seal.
Warning		Wear standard laboratory PPE.
Warning		Do not freeze.
Warning		UV radiation hazard: Protect eyes and skin from exposure.
Warning		Moving parts: Automated Backpressure Valve (ABV) contains moving parts. Keep fingers away from ABV during operation.
Warning		Hot Surface: Do not touch.
Caution		To prevent cracking the Panduit cable organizer, put only one cable in each slot.

3. Compliance information



The KrosFlo® Flat sheet Tangential Flow Filtration (TFF) Systems, or FS-15 and FS-500 a product of Repligen Corporation, is in conformity with the requirements of the European Directive 2006/42/EC and associated amendments with regards to Electromagnetic Compatibility, and the European Directive 2014/35/EC and associated amendments.



Repligen Corporation sources and uses only RoHS compliant materials in all applicable product lines and has met its obligations to the EU WEEE and Battery Directive by registering in those countries to which The Repligen Corporation is an importer. Repligen Corporation has also elected to join WEEE and Battery Compliance Schemes in some countries to help manage customer returns at end-of-life.

The presence of the crossed-out wheeled bin label on this product implies that the product contains electrical or electronic materials that may be hazardous and present a risk to human health and the environment when waste electrical and electronic equipment (WEEE) is not handled correctly. Electrical and electronic

equipment and batteries must be disposed of in an appropriate manner, separate from standard unsorted waste streams. As legislation and disposal facilities may vary throughout the European Union member states, please contact Repligen Corporation (customerserviceus@repligen.com) for further information regarding the proper disposal of products marked with the crossed-out wheeled bin label. For disposal in countries outside of the European Union. This symbol is only valid for use within the European Union (EU). If you wish to discard this product, please contact your local authorities for the correct method of disposal.

Table 2. Product use limitation

Warning:		<p>This product is not designed for, nor intended for use in patient connected applications; including, but not limited to, medical and dental use, and accordingly has not been submitted for FDA approval.</p> <p>This product is not designed for, nor intended for use in hazardous duty areas as defined by ATEX or the NEC (National Electrical Code); including, but not limited to use with flammable liquids. Consult the factory for products suitable for these types of applications.</p>
-----------------	---	---

4. KrosFlo® FS-15 TFF System specifications

Table 3. KrosFlo® FS-15 TFF System output

Description	Specifications
Feed/recirculating pump type	Quattroflow™ QF150SU
Flow rate	0.018 LPM - 3.0 LPM
Flow rate accuracy	±0.1%
Operating pressure	0 - 4 Bar (0 - 58 PSI)
Speed regulation	Line ±0.1% F.S. Load ±0.1% F.S. Drift ±0.1% F.S.
Recommended process volume	150 mL - 15 L
Number of pressure sensors supported	3
Pressure sensor range	-9.99 - 75 PSI
Flat sheet membrane surface area supported	0.1 m ² - 0.3m ²
Number of scales supported	2
Auxiliary pump model	KrosFlo® KRJr
Number of auxiliary pumps supported	2
Auxiliary pumps capacity	0.36 - 380 mL/min

Table 4. KrosFlo® FS-15 TFF System input

Description	Specifications
Power requirements	250 watts
Supply voltage limits	115 - 230 Vrms at 50/60 Hz (Universal Input)
Current, max	2.2 A @ 115 Vrms, or 1.1 A at 230 Vrms

Table 5. KrosFlo® FS-15 TFF System construction

Description	Specifications
Total system weight	61.5 lbs (27.90 kg)
System length	Variable due to system configurability. Recommended lab bench space is 58 in (147 cm)
Enclosure rating	IP33
Display	128 x 64 LCD w/LED Backlight

The KrosFlo® KRJr is recommended for use with the majority of KrosFlo® FS-15 applications. The KR1 pump (ACR1-U20-01R) is also compatible if higher auxiliary pump flow rates are required.

Table 6. KrosFlo® FS-15 TFF System environment

Description	Specifications
Temperature, operating	4° to 40° C (32° to 104° F)
Temperature, storage	-25° to 65° C (-13° to 149° F)
Humidity (non-condensing)	10% – 85%
Altitude	Less than 2000 m
Noise level	<70 dBa at 1 m
Pollution degree	Pollution degree 2
Compliance	For ETL Mark: UL 61010-1, CAN/CSA C22.2 No. 61010-1 For CE Mark: Low Voltage Directive 2014/35/EU Electromagnetic Compatibility Directive 2014/30/EU RoHS Directive 2011/65/EU Environmental Compliance: WEEE (Directive 2012/19/EU) REACH Regulation (EC) No. 1907/2006 California Proposition 65

Table 7. KrosFlo® FS-15 TFF System materials of construction

Description	Material
Enclosure	IP33
Pump Housing	Powder coated PP housing
Flat sheet cassette hardware	Stainless steel
Flow path components	Polypropylene, Polycarbonate, Polysulfone Platinum-cured silicone
Product contact parts	Polypropylene, thermoplastic elastomer, ethylene propylene diene monomer rubber

5. KrosFlo® FS-500 TFF System specifications

Table 8. KrosFlo® FS-500 TFF System output

Description	Specifications
Feed/recirculating pump type	Quattroflow™ QF1200SU
Flow rate	0.20 - 18 LPM
Flow rate accuracy	±0.1%
Operating pressure	0 - 4 Bar (0-58 PSI)
Speed regulation	Line ±0.1% F.S.
	Load ±0.1% F.S.
	Drift ±0.1% F.S.
Permeate flow sensor	SONOFLOW® CO.55
Permeate flow sensor range	0 - 5 LPM
Recommended process volume	1.25 L - 500 L
Number of pressure sensors supported	3
Flat sheet membrane surface area supported	0.5m ² - 1.5m ²
Number of scales supported	2
Auxiliary pumps model	KR1
Auxiliary pumps capacity	0.06 - 2,300 mL/min (Precision tubing pump head P/N ACR2-H3I-01N)
	0.17 - 2,900 mL/min (High Performance pump head P/N ACR2-H4I-01N)

Table 9. KrosFlo® FS-500 TFF System remote outputs

Description	Specifications
Voltage speed	0 - 10 V DC at 1 kΩ min
Current speed	0 - 10 mA at 0-600 Ω
Motor running	N.O. and N.C. contact closure, 1 A at 28 V DC

Table 10. KrosFlo® FS-500 TFF System input

Description	Specifications
Power requirements	520 Watts
Supply voltage limits	115 - 230 Vrms at 50/60 Hz (Universal Input)
Current, max	4.5A @ 115 Vrms, or 2.3 A at 230 Vrms

Table 11. KrosFlo® FS-500 TFF System remote inputs

Description	Specifications
START/STOP, CW, PRIME	Contact closure
Voltage input	0 - 10 V DC at 10 kΩ ±50 V common mode range
Current input	0 - 20 mA or 4 - 20 mA at 250 Ω ±50 V common mode range

Table 12. KrosFlo® FS-500 TFF System construction

Description	Specifications
Whole system weight	152 lbs (68.96 kg)
Whole system length	Variable due to system configurability: Recommended lab bench space is 64 in (163 cm) with Feed Scale off lab bench Recommended lab bench space is 90 in (229 cm) with Feed Scale on lab bench
Enclosure rating	IP33
Display	128 x 64 LCD w/LED Backlight

Table 13. KrosFlo® FS-500 TFF System environment

Description	Specifications
Temperature, operating	4° to 40° C (32° to 104° F)
Temperature, storage	-25° to 65° C (-13° to 149° F)
Humidity (non-condensing)	10% - 85%
Altitude	Less than 2000 m
Noise level	< 70 dBA at 1 m
Pollution degree	Pollution degree 2
Chemical resistance	Pump Housing: Powder-coated stainless steel Flat sheet cassette hardware: stainless steel Flow path components: Polypropylene; Polycarbonate; Polysulfone Platinum-Cured Silicone
Compliance	For ETL Mark: UL 61010-1, CAN/CSA C22.2 No. 61010-1 For CE Mark: Low Voltage Directive 2014/35/EU Electromagnetic Compatibility Directive 2014/30/EU RoHS Directive 2011/65/EU Environmental Compliance: WEEE (Directive 2012/19/EU) REACH Regulation (EC) No. 1907/2006 California Proposition 65

Table 14. KrosFlo® FS-500 TFF System materials of construction

Description	Specifications
Enclosure	Stainless steel enclosure models: 316 stainless steel enclosure and hard-coat anodized aluminum Powder-coated enclosure models: Polyester-coated steel enclosure steel and hard-coat, anodized aluminum
Product contact parts	Polypropylene, thermoplastic elastomer, ethylene propylene diene monomer rubber

6. Unboxing checklist

This section lists the items included with the KrosFlo® FS-15 Complete TFF System (part numbers SYFS-015-2 and SYFS-015-2C).



NOTE: *Unpack all items with care to prevent damage prior to use. During installation make certain that all items are securely fastened together prior to use. Ensure the Surface Pro tablet is securely fastened within the case and to the mount before mounting it to the system.*



CAUTION: *The weight of the main pump is more than 25 lbs. Two people are recommended to lift it out of the box and place it on the bench.*

Table 15. KrosFlo® FS-15 TFF System unboxing checklist

#	Item	Dimensions	Weight	Quantity	Check
1	Base pump with QF150SU EZ head	11.5 x 10.5 x 17 in (29.2 x 26.7 x 43.2 cm)	25.2 lbs (11.5 kg)	1	[]
2	Component communication cable, 31 pin (1 of 2 octopus cables) – 7 outlet	1 x 5 x 5 in (2.5 x 12.7 x 12.7 cm)	0.74 lbs (0.34 kg)	1	[]
3	Pressure sensor communication cable, 18 pin (2 of 2 octopus cables) – 3 outlet	1 x 6 x 6 in (2.5 x 15.2 x 15.2 cm)	0.15 lbs (0.07 kg)	1	[]
4	Microsoft Surface Pro tablet with KF Comm 2 Software and mount	1 x 10 x 14 in (2.5 x 25.4 x 35.6 cm)	3.5 lbs (1.6 kg)	1	[]
5	TangenX® SIUS PD 2-bolt cassette clamp	2.5 x 9 x 9.5 in (6.4 x 22.9 x 24.1 cm)	16.7 lbs (7.6 kg)	1	[]
6	Filter plate insert	8.8 x 2.5 x 1 in (22.4 x 6.4 x 2.5 cm)	0.29 lbs (0.13 kg)	1	[]
7	Automatic Backpressure Control Valve (ABV) with vacuum base	4 x 4 x 6 in (10.2 x 10.2 x 15.2 cm)	3.2 lbs (1.44 kg)	1	[]
8	Schuler scale, 20 kg capacity	4 x 8.5 x 12.5 in (10.6 x 21.6 x 31.8 cm)	4.6 lbs (2.1 kg)	2	[]
9	KRJR pump drive, 300 RPM	5.5 x 7 x 6.3 in (14.0 x 17.8 x 16 cm)	4.8 lbs (2.18 kg)	1	[]
10	Magnetic stirrer and stirring bar	1 x 6 x 6.5 in (2.5 x 15.2 x 16.5 cm)	1.7 lbs (0.77 kg)	1	[]
11	ProConnex® Single-use Flow Path (kit of 5 tubing sets). Includes three integrated, ½" TC pressure transducers.	Variable lengths	0.9 lbs (0.41 kg)	1 Set	[]
12	1 L, flat bottom, 4-ported reservoir	3.5 x 10.5 in (8.9 cm x 26.7 cm)	.57 lbs (0.26 kg)	1	[]
13	Tablet power block with Microsoft connector and C7 jumper cable	48 in cable length	0.1 lbs (0.05 kg)	2	[]
14	Power strip, universal, C14 inlet, sheet F outlets	2 x 2.2 x 13.5 in (5.0 x 5.7 x 34.3 cm)	1.6 lbs (0.74 kg)	1	[]
15	Power cord for power strip	78.7 in (200 cm)	0.37 lbs (0.17 kg)	1	[]
16	Power cord universal jumpers (multiple lengths)	(6) 19.4 in (50 cm) (1) 59.1 in (150 cm)	0.22 – 0.84 lbs (0.1 – 0.38kg)	7	[]
17	Stir plate power cable and jumper cable adaptor (CEE7)	2 x 2.2 x 30 in (5.0 x 5.7 x 34.3 cm)	0.46 lbs (0.21 kg)	1	[]
18	Panduit cable organizer	4 x 6 x 20 in (50.8 cm)	1.7 lbs (0.75 kg)	1	[]

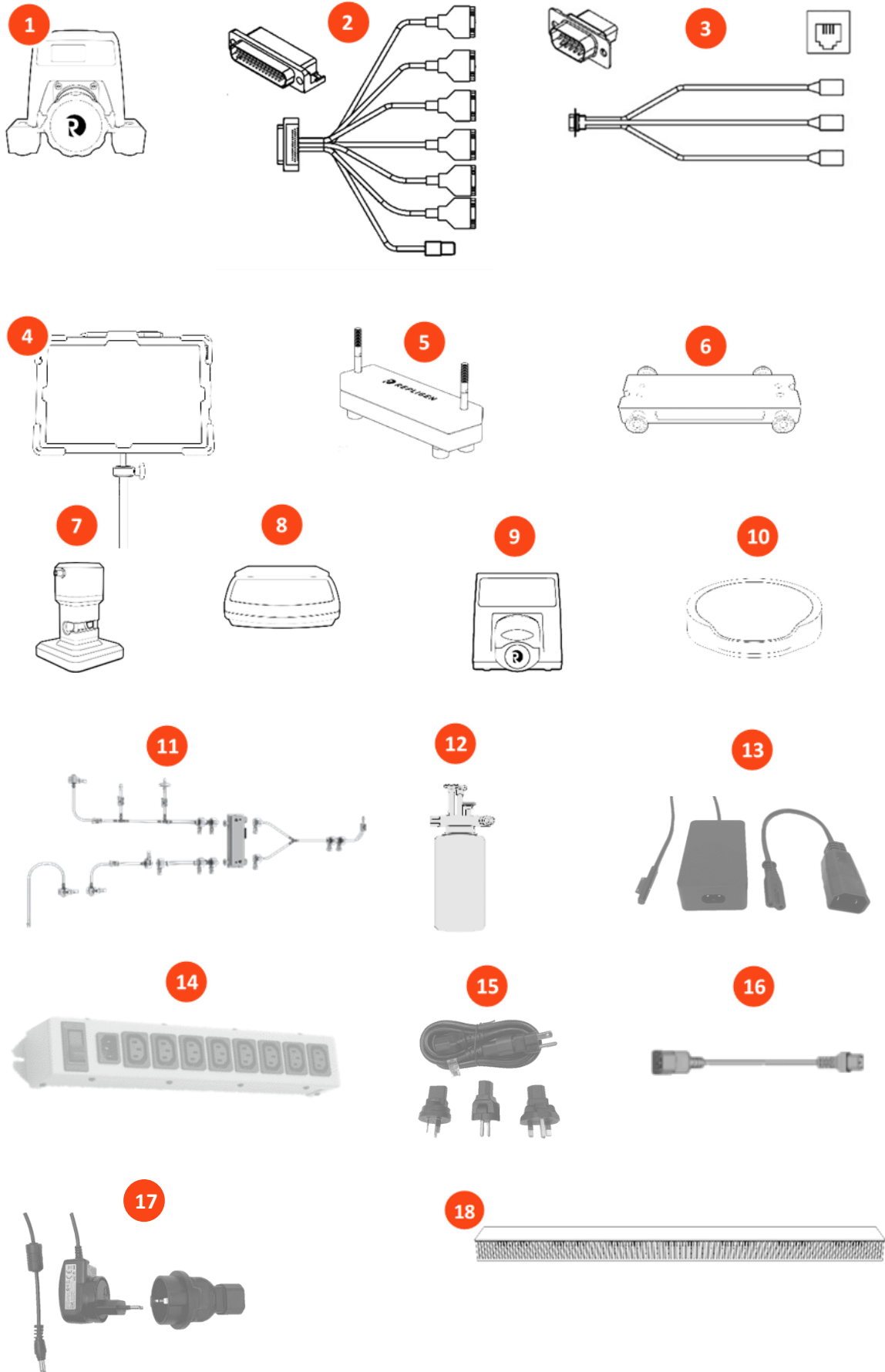

This section lists the items included with the KrosFlo® FS-500 Complete TFF System (part numbers SYFS-500-2 and SYFS-500-2C).



NOTE: *Unpack all items with care to prevent damage prior to use. During installation make certain that all items are securely fastened together prior to use. Ensure the Surface Pro tablet is securely fastened within the case and to the mount before mounting it to the system.*



CAUTION: *The weight of the main pump is more than 25 lbs. Two people are recommended to lift it out of the box and place it on the bench.*

Table 16. KrosFlo® FS-500 TFF System unboxing checklist

#	Item	Dimensions	Weight	Quantity	Check
1	Base pump with QF1200SU EZ head	25 x 11 x 13 in (63.5 x 27.9 x 33.0 cm)	58.5 lbs (26.5 kg)	1	[]
2	Component communication cable, 31 pin (1 of 2 octopus cables) - 7 outlet	1 x 5 x 5 in (2.5 x 12.7 x 12.7 cm)	0.74 lbs (0.34 kg)	1	[]
3	Pressure sensor communication cable, 18 pin (2 of 2 octopus cables) - 3 outlet	1 x 6 x 6 in (2.5 x 15.2 x 15.2 cm)	0.3 lbs (0.13 kg)	1	[]
4	Microsoft Surface Pro tablet with KF Comm 2 Software and mount	1 x 10 x 14 in (2.5 x 25.4 x 35.6 cm)	3.5 lbs (1.6 kg)	1	[]
5	TangenX SIUS PD 4-bolt cassette clamp	2.5 x 9 x 9.5 in (6.4 x 22.9 x 24.13 cm)	16.7 lbs (7.6 kg)	1	[]
6	Filter plate	8.8 x 9.8 x 2 in (22.4 x 24.9 x 5.1 cm)	4.6 lbs (2.1 kg)	1	[]
7	Automatic Backpressure Valve (ABV)	4 x 4 x 6 in (10.2 x 10.16 x 15.2 cm)	3.2 lbs (1.4 kg)	1	[]
8	Schuler scale, 60 kg capacity	20 x 21.5 x 4 in (50.8 x 54.6 x 10.2 cm)	26.7 lbs (12.1 kg)	1	[]
9	KR1 pump drive, 600 RPM	15 x 8 x 10 in (38.1 x 20.3 x 25.4 cm)	17.0 lbs (7.71 kg)	1	[]
10	ProConnex single-use flow path (kit of 5 tubing sets). Includes three integrated, ½" pressure transducers.	Variable lengths	2.1 lbs (0.95 kg)	1 Set	[]
11	20 L, flat bottom, 4-ported reservoir	3.5 x 10.5 in (8.9 cm x 26.7 cm)	7.3 lbs (3.3 kg)	1	[]
12	Flow sensor interface module	7 x 4 x 3.5 in (17.8 x 10.16 x 8.9 cm)	1.0 lbs (0.45 kg)	1	[]
13	Flow sensor	1.7 x 1.7 x 1.3 (4.4 x 4.4 x 3.4 mm)	0.31 lbs (0.14 kg)	1	[]
14	Tablet power block with Microsoft connector and C7 jumper cable	48 in (121.9 cm)	0.1 lbs (0.05 kg)	2	[]
15	Power strip, universal, C14 inlet, sheet F outlets	2 x 2.2 x 13.5 in (5.0 x 5.7 x 34.3 cm)	1.6 lbs (0.74 kg)	1	[]
16	Power cord for power strip	19.7 in (50 cm)	0.37 lbs (0.17 kg)	1	[]
17	Power cord universal jumpers (multiple lengths)	(3) 19.4 in (50 cm) (2) 59.1 in (150 cm) (1) 98.4 in (250 cm)	0.22 – 0.84 lbs (0.1 -0.38kg)	6	[]
18	Panduit cable organizer	4 x 6 x 20 in (50.8 cm)	1.7 lbs (0.75 kg)	1	[]
19	Base plate	31 x 20 in (78.7 x 50.8 cm)	10 lbs (4.5 kg)	1	[]
20	KR1 pump drive AC jumpers	59.1 in (150 cm)	0.41 lbs (0.19 kg)	2	[]

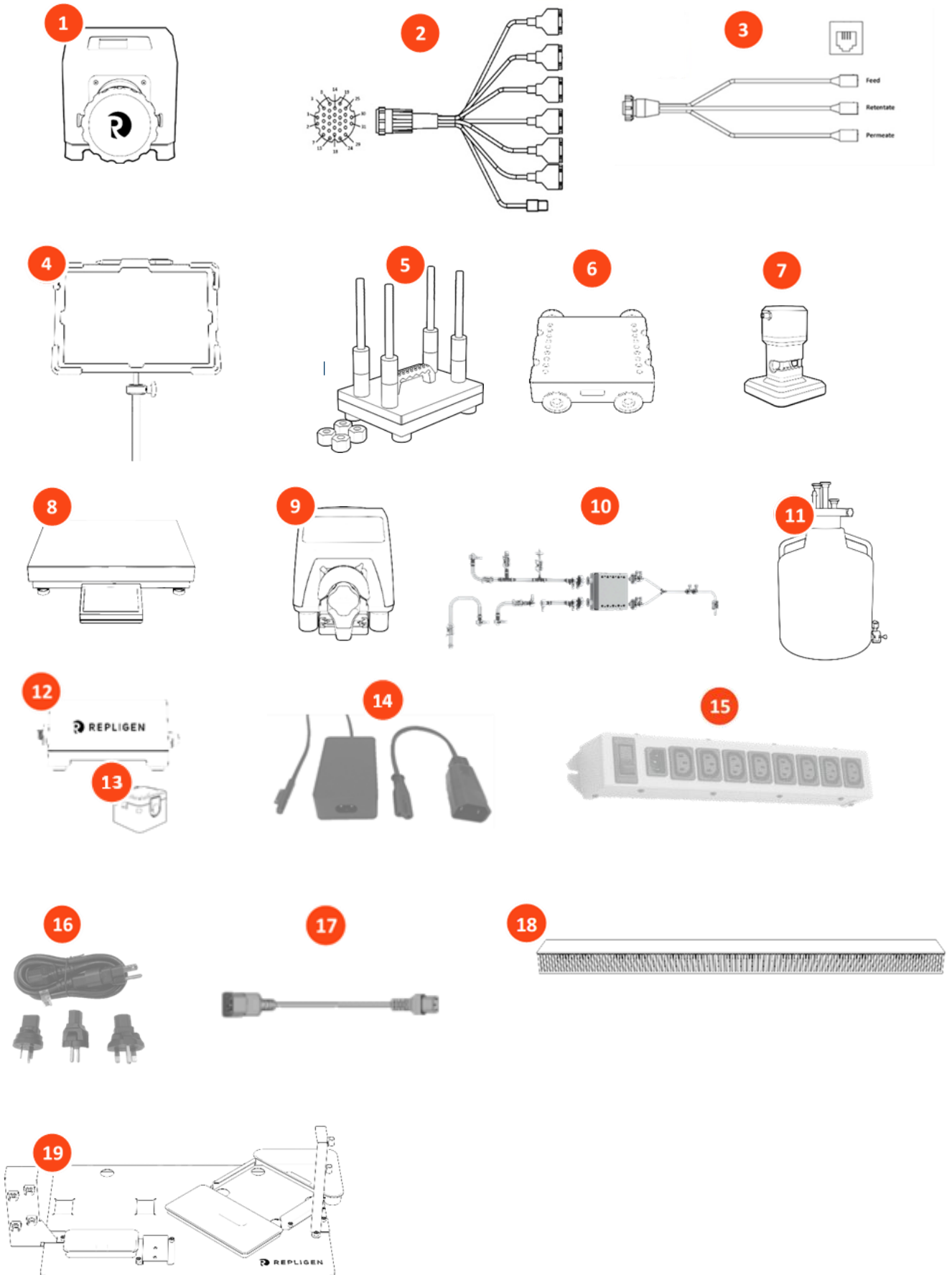

7. Optional purchases

Table 17. KrosFlo® FS-15 TFF System additional components

Item	Part number
KrosFlo® KRJr Pump Drive 300 RPM	ACJR-U10-R
KR1 Auxiliary Pump, 600 RPM	ACR1-U20-01R
ProConnex Standard Flow Path, high pressure	STUBEGN16315N
Scale, 20 kg capacity	SCL-0020-SCLR
Scale, 60 kg capacity	SCL-0060-SCLR
Pro PD Torque Wrench, includes 11/16" socket adaptor	TX019
Konduit Base Unit	ACCD-BR
UV Photometer 280 nm; includes UV Flow Cells ACUF-12HB and ACUF-14HB	ACCD-U280
UV Photometer 260 nm; includes UV Flow Cells ACUF-12HB and ACUF-14HB	ACCD-U260
Conductivity Sensor, Single-use, non-sterile, PS, 1/4" HB	ACCS-14HB
Conductivity Sensor, Single-use, non-sterile, PS, 1/2" HB	ACCS-12HB
UV Flow Cell, Single-use, 0.5cm PL, non-sterile, PS 1/4" HB	ACUF-14HB
UV Flow Cell, Single-use, 0.5cm PL, non-sterile, PS 1/2" HB	ACUF-12HB

Table 18. KrosFlo® FS-500 TFF System additional components

Item	Part number
KR1 Auxiliary Pump, 600 RPM	ACR1-U20-01R
I/P Pump Drive, 650 RPM	ACM3-U10
ProConnex Standard Flow Path, high pressure	STUBEGN16316N
Scale, 60 kg capacity	SCL-0060-SCLR
Pro Torque Wrench, includes 1 1/4" socket adaptor	TX026
Digital Magnetic Stirrer, 1000 RPM – 120/100 V	ACFS-SP500-120
Digital Magnetic Stirrer, 1000 RPM – 230/100 V	ACFS-SP500-230
Konduit Base Unit	ACCD-BR
UV Photometer 280 nm; includes UV Flow Cells ACUF-12HB and ACUF-14HB	ACCD-U280
UV Photometer 260 nm; includes UV Flow Cells ACUF-12HB and ACUF-14HB	ACCD-U260
Conductivity Sensor, Single-use, non-sterile, PS, 1/4" HB	ACCS-14HB
Conductivity Sensor, Single-use, non-sterile, PS, 1/2" HB	ACCS-12HB
UV Flow Cell, Single-use, 0.5cm PL, non-sterile, PS 1/4" HB	ACUF-14HB
UV Flow Cell, Single-use, 0.5cm PL, non-sterile, PS 1/2" HB	ACUF-12HB

8. Set-up

Figure 1. Space requirements for KrosFlo® FS-15

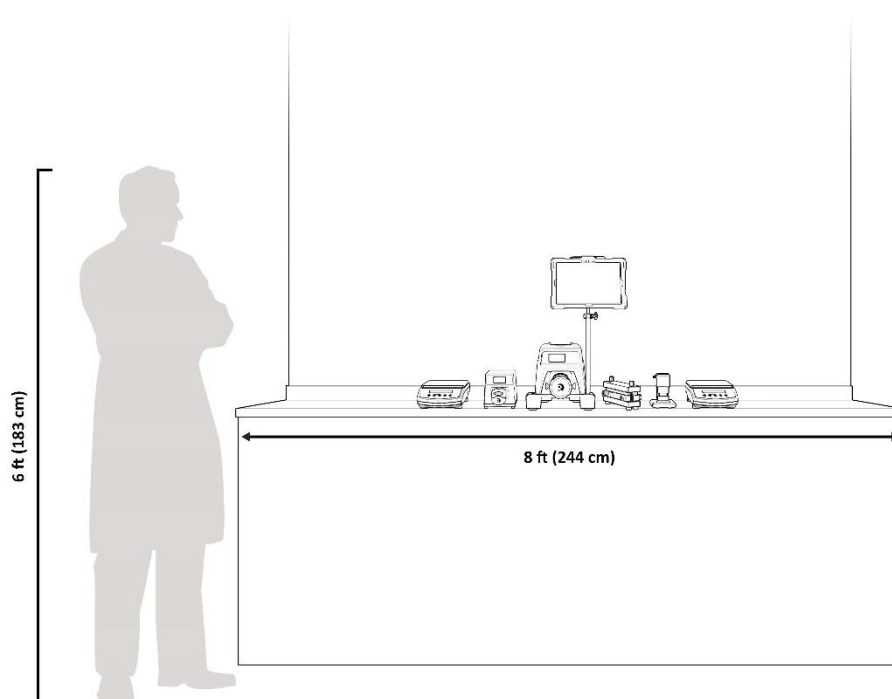

Figure 2. Space requirements for KrosFlo® FS-500 - Option A

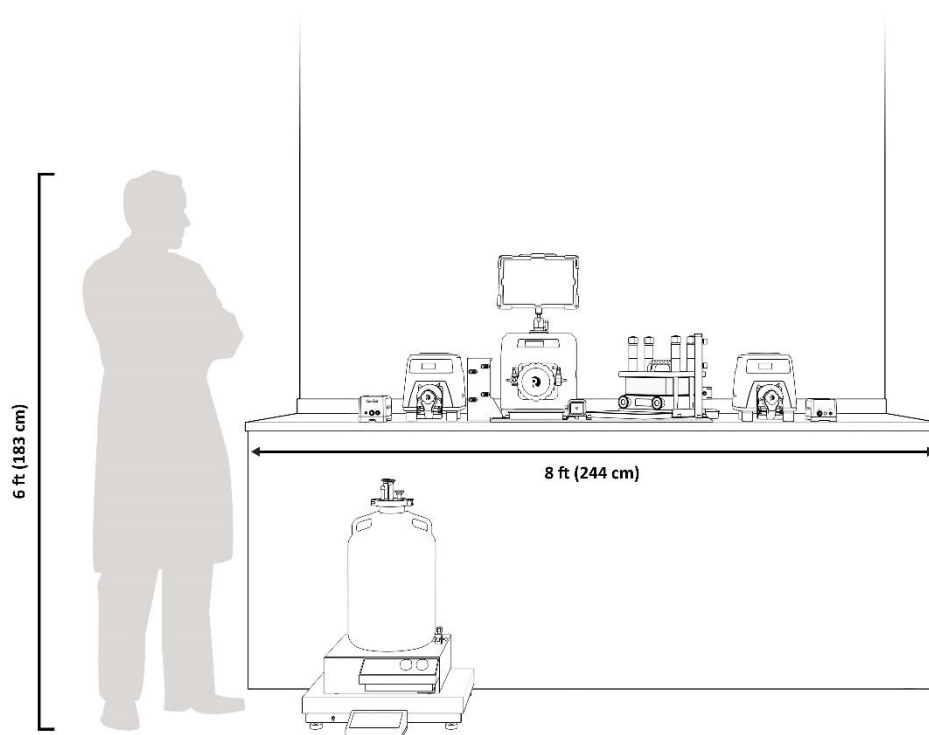
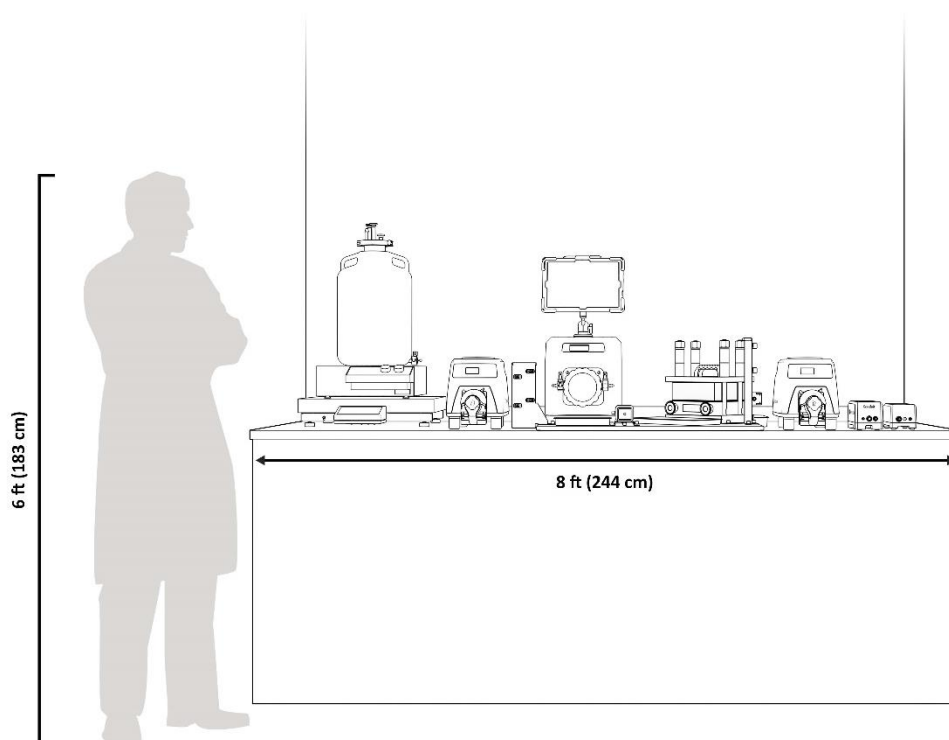
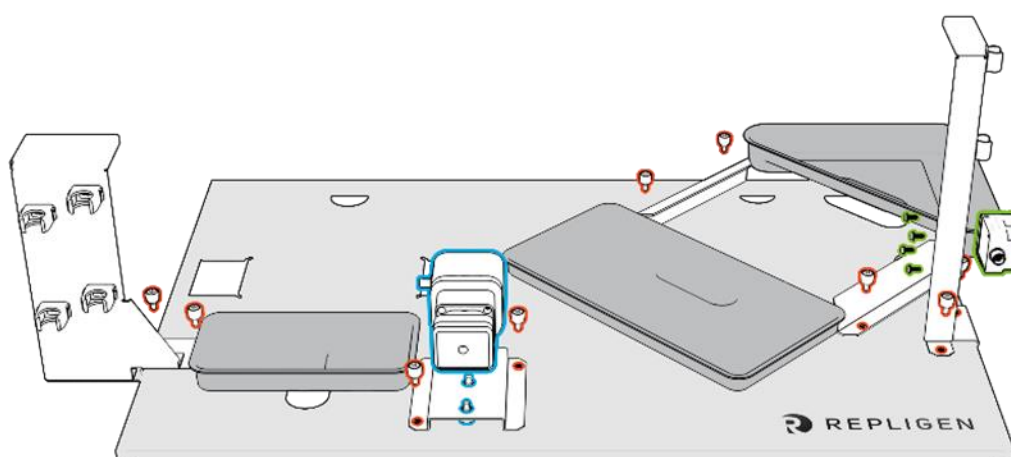

Figure 3. Space requirements for KrosFlo® FS-500 - Option B

8.1 KrosFlo® FS-500 base plate

The KrosFlo® FS-500 base plate controls the location of system components to:

- Minimize holdup volumes
- Allow the use of off-the-shelf tube sets
- Locate drip trays where disassembly may take place
- Securely mount ABV, cassette holder, and permeate flow meter
- Ease the torquing of the cassette holder nuts

Figure 4. KrosFlo® FS-500 Base plate set-up

8.2 Assembling the base plate

All base plate components have captured fasteners (shown in red) to eliminate losing hardware. The fasteners can be hand tightened or secured with a Phillips screwdriver.

1. Place the base plate close to the front and center of the lab bench with the Repligen logo on the right side.

2. Using a two-person lift technique, place the front feet of the base pump into the two rectangular cutouts. No additional hardware is required to seat the pump.
3. Place the feet of the cassette holder into the four circular cutouts.
4. Use the brackets to secure the cassette holder to the base plate to aid with nut torquing.
5. Mount the ABV (shown in blue) to its mounting bracket and mount the bracket to the front center of the base plate with the opening for the tubing to the front.
6. Place the three drip trays into the oval cut outs as shown.
7. Mount the permeate flow meter (shown in green) to the permeate tubing organizer bracket and mount the bracket to the right side of the base plate.
8. Mount one of the two feed-retentate tubing organizing brackets (one is for small OD tubes and one is for large OD tubes) to the left side of the base plate, as appropriate for your setup.

9. System cable connections

Figure 5. KrosFlo® FS-15 TFF System cable connections

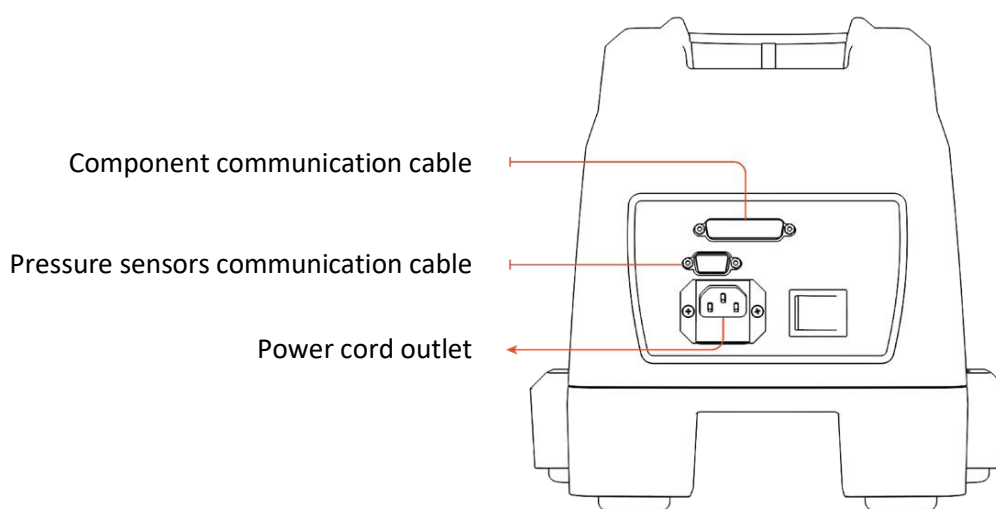
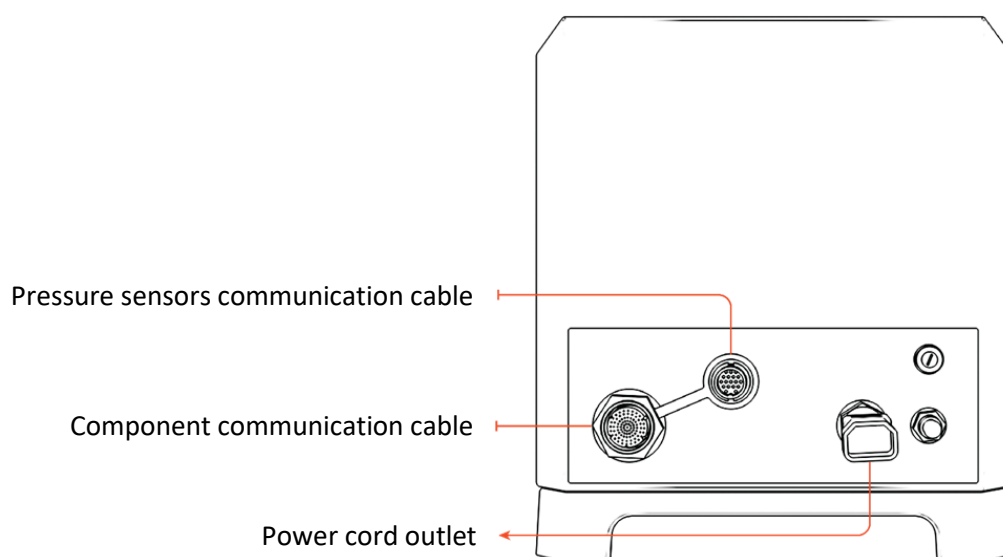

Figure 6. KrosFlo® FS-500 TFF System cable connections



10. Software set up

This section provides only a basic overview of software setup. For complete software and system instructions, see the KF Comm 2 Software User Guide (IF.UG.022).

The KrosFlo® FS Systems are controlled using software that can be installed either on the provided tablet or on a computer provided by the customer. The provided tablet is fully unlocked to the end user.

The system is required to have internet access enabled for the setup process, but it is not required during routine operation. Internet access will also be required for all subsequent KF Comm 2 software and firmware updates.

10.1 Minimum system requirements for optional, customer-provided computer

- Windows 10
- 8 GB RAM or greater
- Intel® Core™ i5, equivalent or faster processor
- Symantec Antivirus or equivalent

This computer must be local to the KrosFlo® System and will require physical connectivity to the KrosFlo® System auxiliary octopus cable. This computer will also be required to have internet access enabled for the setup process, but internet access is not required during routine operation.

10.2 Supported control software

- KF Comm 2
- KF Comm 2C (21 CFR part 11 compliance-ready)

10.3 Setting up the software (overview)

See the KF Comm 2 Software User Guide (IF.UG.022) for details regarding how to complete the following set up tasks.

1. Ensure your super user account has been created and that your super user has received an email with the account information from Repligen. If you are unsure if an account has been set up or require the email to be resent, contact Repligen customer service team at customerserviceus@repligen.com.
2. Download and install the software.
3. Log in and activate the license.
4. Create the user accounts.
5. Update the pump firmware.

11. Tube set installation

The following diagram depicts the standard flowpath (STUBEGN16315N) for the KrosFlo® FS-15 System for illustrative purposes. Each FS System standard flow path contains five (5) sets of tubing engineered specifically to meet system specifications for high pressure applications up to 4 bar (58 psi). The five sets of tubing [Feed tube set, reinforced feed tube set, retentate tube set, permeate tube set and auxiliary tube set] correspond to specific installation locations and should always be installed as recommended in this set-up guide.

The standard flowpath for the KrosFlo® FS-500 System (STUBEGN16316N) contains similar tubing section configurations, but specifically sized and fitted to the FS-500 footprint.

Figure 7. KrosFlo® FS-15 tube set

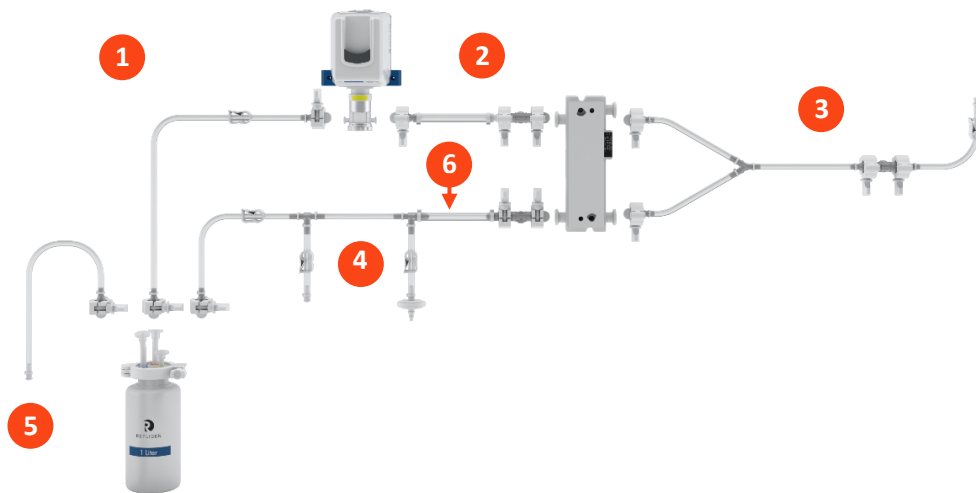

#	Description
1	Feed tube set
2	Reinforced feed tube set
3	Permeate tube set
4	Retentate tube set
5	Auxiliary tube set
6	Recommended location of the ABV

11.1 Tube set guidelines

The KrosFlo® FS Systems are designed to accommodate high-pressure applications up to pressures of 4 bar (58 psig) with use of the specified ProConnex flow paths. To ensure safe operation of the KrosFlo® FS Systems it is important to adhere to the following guidelines:

- Install only tube sets designed for high-pressure applications.
- Remove all end caps and/or terminal plugs prior to making connections.
- To minimize unintended air ingress or fluid leakage, securely fasten each connection, being sure to fully seat gaskets.
- Verify the flow path is correctly oriented through the base pump, as indicated by the directional arrow on the pump head.
- To optimize dip-tube configurations, connect each tube set to the designated port. The ports are color coded for clarity.

Designated ports:

- Orange – Recirculation inlet (retentate line to reservoir vessel)
 - Blue – Reservoir outlet (reservoir vessel to base pump)
 - Yellow Auxiliary inlet – (auxiliary pump to reservoir vessel)
 - Green – Vent
- Following tube set installation and prior to use, perform the following checks:
 - Review the setup and verify each connection has been fully fastened.
 - Ensure that all pinch clamps are in the correct position.
 - Ensure pressure transducers have been connected to the appropriate octopus cable connector and are operational.
 - ProConnex® tube sets are designed and intended for single-use only. Repeated use is at the discretion of the end user.
 - For custom ProConnex® Flow Path configurations, contact your Bioprocess Account Manager.

11.2 Feed tube set installation

This tube set connects the reservoir vessel to the base pump.

1. Connect one end of the feed tube set to the base pump inlet and secure with a clamp and gasket.
2. Connect the other end of the feed tube to the outlet port on the reservoir vessel cap (blue connection) and secure with a clamp and gasket.

11.3 Reinforced feed tube set

This tube set is one of two reinforced flow path sections required for high-pressure operation. Repligen recommends that the pressure transducers be located nearest the cassette filter holder for the most accurate representation of cassette pressure profile.

1. Connect the tubing (pressure transducer end) to the cassette Filter Plate Insert (FPI) inlet and secure it with a clamp and gasket.
2. Connect the remaining end to the base pump outlet and secure with clamp and gasket.

11.4 Retentate tube set

The retentate tube set contains the retentate pressure transducer, auxiliary port, and air inlet port for air integrity testing of membranes. This tube set also contains a section of reinforced tubing critical for proper Automatic Backpressure Valve (ABV) placement and operation.

1. Lay the retentate tube set on the lab bench in front of the system, being careful to align the auxiliary port and air inlet port facing outward toward operator. This recommended orientation allows easier access to these ports, but other orientations may be used, as needed.
2. Connect the tubing end containing the inline pressure transducer to the retentate outlet of the FPI and secure with a clamp and gasket.
3. Secure the remaining end of the retentate tube set to the corresponding inlet port of the reservoir vessel cap (orange connection) with a clamp and gasket.
4. Install the reinforced tubing into the ABV.
 - **KrosFlo® FS-15 System** - Secure the ABV to the countertop in a position that allows the reinforced retentate tubing section, located after the retentate pressure transducer, to be linearly inserted into the ABV.
 - **KrosFlo® FS-500 System** - Lay the reinforced retentate tubing through the plate-mounted ABV.

11.5 Permeate Tube Set

The permeate tube set manifolds the two permeate ports from the filter plate insert and is designed with an open terminal end to allow the end user-specified adaptation.

1. Connect the two manifolded ends to the corresponding permeate ports of the FPI and secure with a clamp and gasket.
2. Direct the open end of the permeate tubing to the waste stream collection vessel, drain, or outlet.

11.6 Auxiliary tube set installation

The auxiliary tube set is provided for use with an auxiliary pump to transfer process fluids (feed stock, buffer, water, etc.) from an external source to the reservoir vessel. The tubing is designed with one open terminal end to allow end user-specified adaptation.

1. Connect the sanitary fitting to the corresponding buffer port of the reservoir vessel cap (yellow connection) with clamp and gasket.

11.7 Permeate Flowmeter (KrosFlo® FS-500 only)

The ultrasonic flowmeter is factory-calibrated to the tubing to ensure highest accuracy. Changes to the intended tubing can result in a loss of accuracy due to the differing properties of the tubing material and varying ID/OD dimensions. For the KrosFlo® FS-500 Complete System, the flowmeter has been factory calibrated to the size #17 silicone tubing.

The flowmeter can be mounted to the tubing management tower in a horizontal or vertical orientation.

To install tubing into the flow sensor:

1. Carefully open the cover and lay the tubing in channel, being careful not to stretch the tubing.
2. Close and fasten the cover.
Always check that the cover is fastened before use

12. Index

Caution.....	7, 12, 14	Set-up.....	6, 17
Compliance	7, 9, 11	Software.....	6, 20
Components.....	6, 7, 9, 11, 16, 18	System specifications.....	8, 10
Note	12, 14	Tube set installation	21
Safety	7	Unboxing checklist.....	12